

! INFO !

- (DE) Die Batterie des Zugfahrzeugs bzw. gezogenen Fahrzeugs nicht direkt über die Steckdose aufladen.
- (FR) Ne pas charger les batteries du véhicule tracteur et/ou tracté directement sur la prise de courant.
- (NL) De accu van het trekkend voertuig c.q. getrokken voertuig niet rechtstreeks via de contactdoos opladen.
- (GB) Do not charge the battery of the towing vehicle and/or towed vehicle directly via the socket.
- (ES) No recargue la batería del vehículo remolque y/o del remolcado directamente mediante el enchufe.
- (IT) Non caricare la batteria del veicolo trainante o di quello trainato direttamente dalla presa.
- (SE) Ladda inte batteriet i det bogserande fordonet och/eller det bogserade fordonet direkt via kontakten.
- (CZ) Nenabíjajte baterii tažného ani taženého vozidla přes zásuvku.
- (DK) Oplad ikke bugseringskøretøjet og/eller det bugserede køretøjs batteri direkte v.h.a. stikdåsen.
- (FI) Älä lataa hinaavan ajoneuvon ja/tai hinattavan ajoneuvon akkua suoraan pistorasian kautta.
- (GR) Μη φορτίζετε την μπαταρία του ρυμουλκούμενου οχήματος και/ή ρυμουλκημένου οχήματος απευθείας μέσω του ρευματοδότη.
- (NO) Batteriet til kjøretøyet som trekker eller blir trukket skal ikke lades direkte via koblingsboksen.
- (PL) Nie ładować akumulatora pojazdu holującego/holowanego bezpośrednio przez gniazdo.

- (DE) Gebrauchsanleitung
(FR) Mode d'emploi
(NL) Gebruikershandleiding
(GB) User guide
(ES) Guía del usuario
(IT) Manuale di istruzioni
(SE) Bruksanvisning
(CZ) Uživatelská příručka
(DK) Brugervejledning
(FI) Käyttöohjeet
(GR) Οδηγός χρήστη
(NO) Brukerveiledning
(PL) Instrukcja obsługi

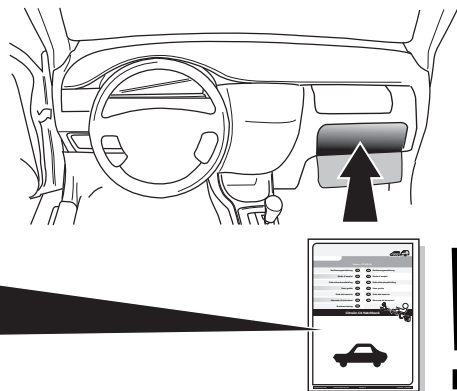

SPARE PARTS

www.ecs-electronics.com

ECS

ELECTRONICS



Partnr.: AF-010-BB

Gebrauchsanleitung (DE)

(CZ) Uživatelská příručka

Mode d'emploi (FR)

(DK) Brugervejledning

Gebruikershandleiding (NL)

(FI) Käyttöohjeet

User guide (GB)

(GR) Οδηγός χρήστη

Guía del usuario (ES)

(NO) Brukerveiledning

Manuale di istruzioni (IT)

(PL) Instrukcja obsługi



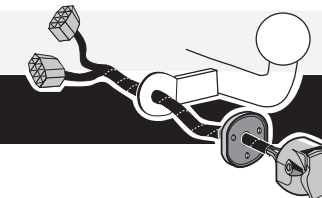

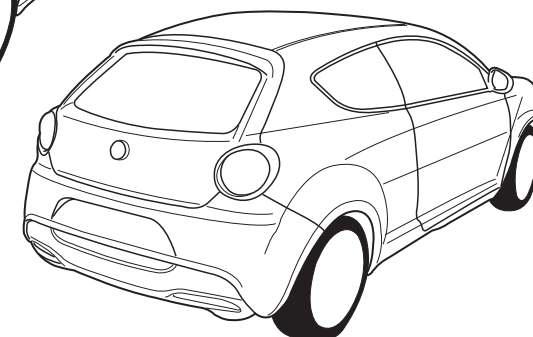
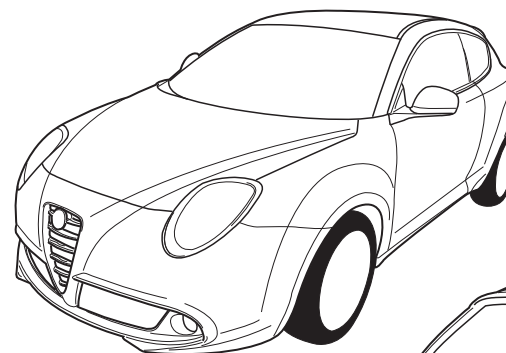

Bruksanvisning (SE)



Alfa Romeo MiTo 2008-



- | | |
|-------------------------------------|-------------------------------|
| (DE) Anschluss Steckdose | (CZ) Objímkový konektor |
| (FR) Connection de la prise | (DK) Stikdåse forbindelse |
| (NL) Contactdoos aansluiting | (FI) Pistorasia liitäntä |
| (GB) Socket connection | (GR) Υποδοχή σύνδεσης |
| (ES) Conexión de la caja de enchufe | (NO) Tilkobling koblingsboks |
| (IT) Allaccio zoccolo | (PL) Połączenie przez gniazdo |
| (SE) Anslutning kontaktdosa | |

DIN/ISO 1724			 1-7				
	1/L	2	3/31	4/R	5/58-R	6/54	7/58-L
Pmax	21W	2x21W		21W	52W	3x21W	52W
(DE)	Gelb	Blau	Weiß	Grün	Braun	Rot	Schwarz
(FR)	Jaune	Bleu	Blanc	Vert	Marron	Rouge	Noir
(NL)	Geel	Blauw	Wit	Groen	Bruin	Rood	Zwart
(GB)	Yellow	Blue	White	Green	Brown	Red	Black
(ES)	Amarillo	Azul	Blanco	Verde	Marrón	Rojo	Negro
(IT)	Giallo	Blu	Bianco	Verde	Marrone	Rosso	Nero
(SE)	Gul	Blå	Vit	Grön	Brun	Röd	Svart
(CZ)	Žlutá	Modrá	Bílá	Zelená	Hnědá	Červená	Černá
(DK)	Gul	Blå	Hvid	Grøn	Brun	Rød	Sort
(FI)	Keltainen	Sininen	Valkoinen	Vihreä	Ruskea	Punainen	Musta
(GR)	Κίτρινο	Μπλε	Λευκό	Πράσινο	Καφέ	Κόκκινο	Μαύρο
(NO)	Gul	Blå	Hvit	Grønn	Brun	Rød	Svart
(PL)	Żółty	Niebieski	Biały	Zielony	Brązowy	Czerwony	Czarny

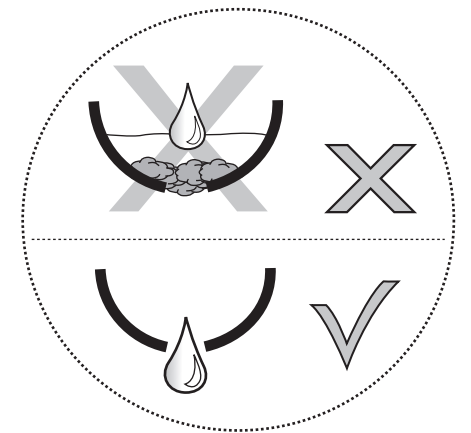
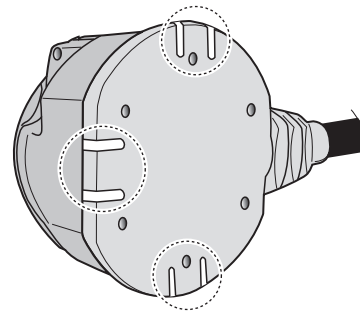

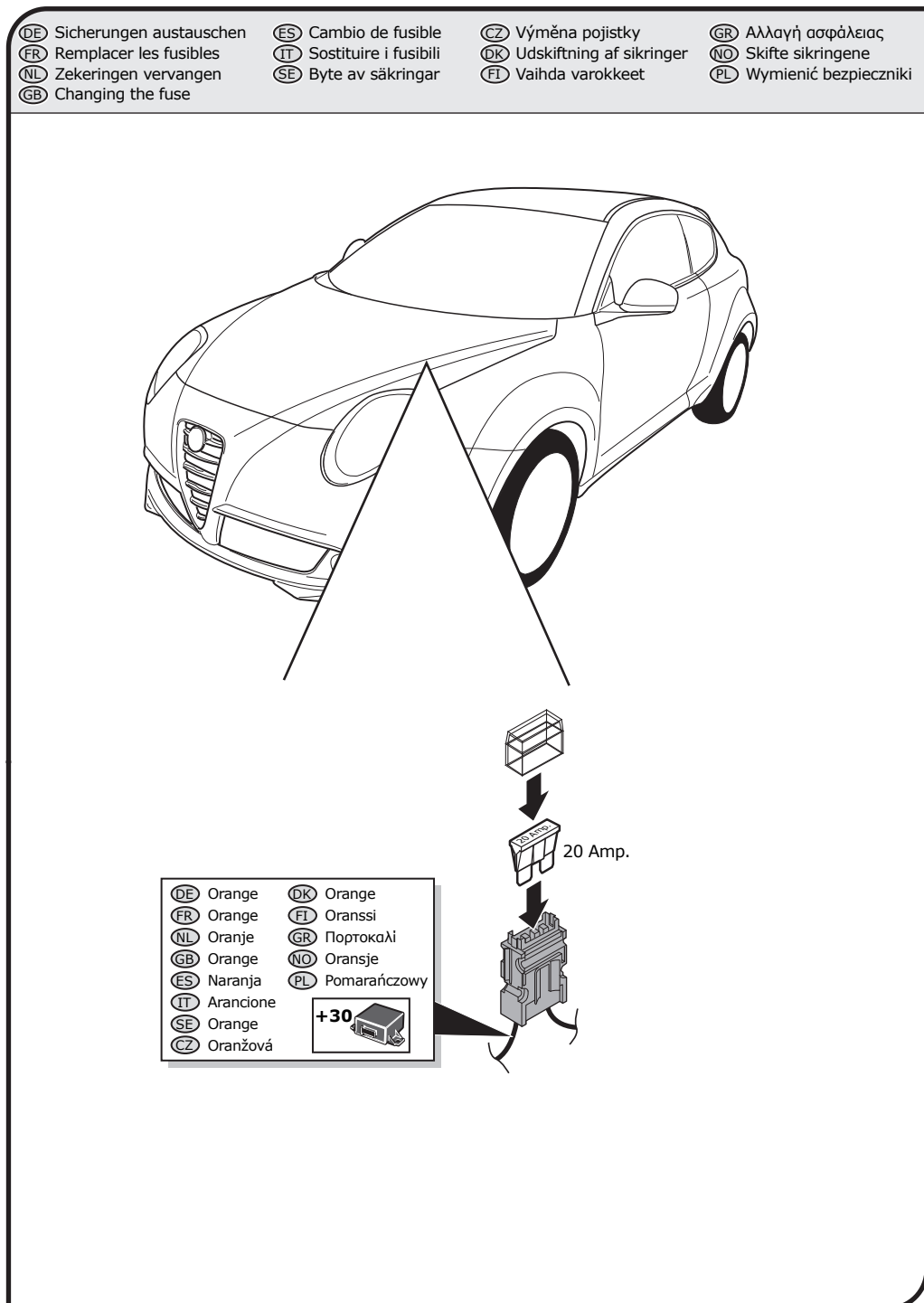
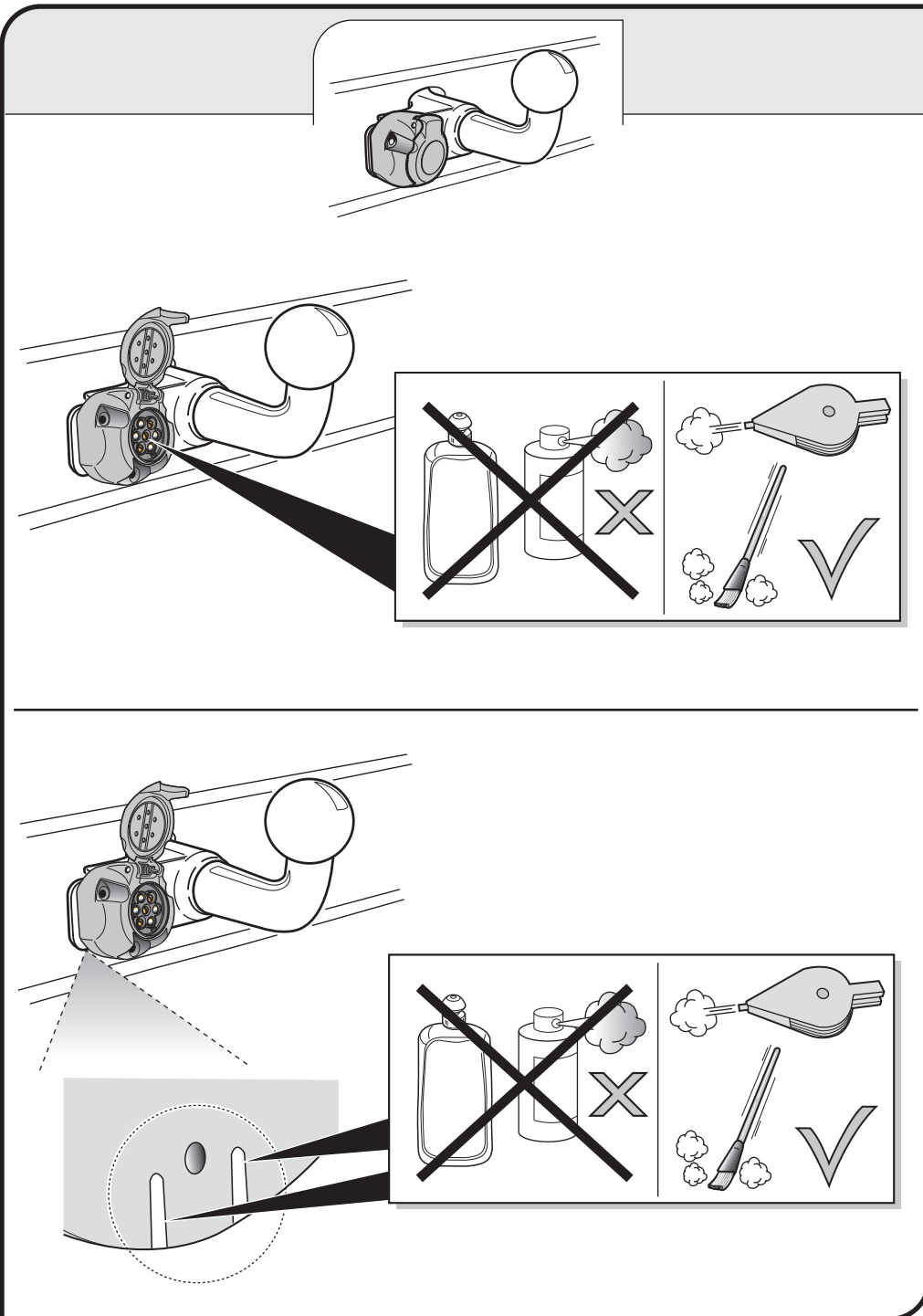

- | | | | |
|----------------------------|--------------------------|-----------------------------|--------------------------|
| DE Sicherungen austauschen | ES Cambio de fusible | CZ Výměna pojistky | GR Αλλαγή ασφάλειας |
| FR Remplacer les fusibles | IT Sostituire i fusibili | DK Udskiftning af sikringer | NO Skifte sikringene |
| NL Zekeringen vervangen | SE Byte av säkringar | FI Vaihda varokkeet | PL Wymienić bezpieczniki |
| GB Changing the fuse | | | |

- | | |
|--------------|-----------------|
| DE Orange | DK Orange |
| FR Orange | FI Oranssi |
| NL Oranje | GR Πορτοκαλι |
| GB Orange | NO Oransje |
| ES Naranja | PL Pomarańczowy |
| IT Arancione | |
| SE Orange | |
| CZ Oranžová | |
- +30**

